

Power valves pneumatic actuator

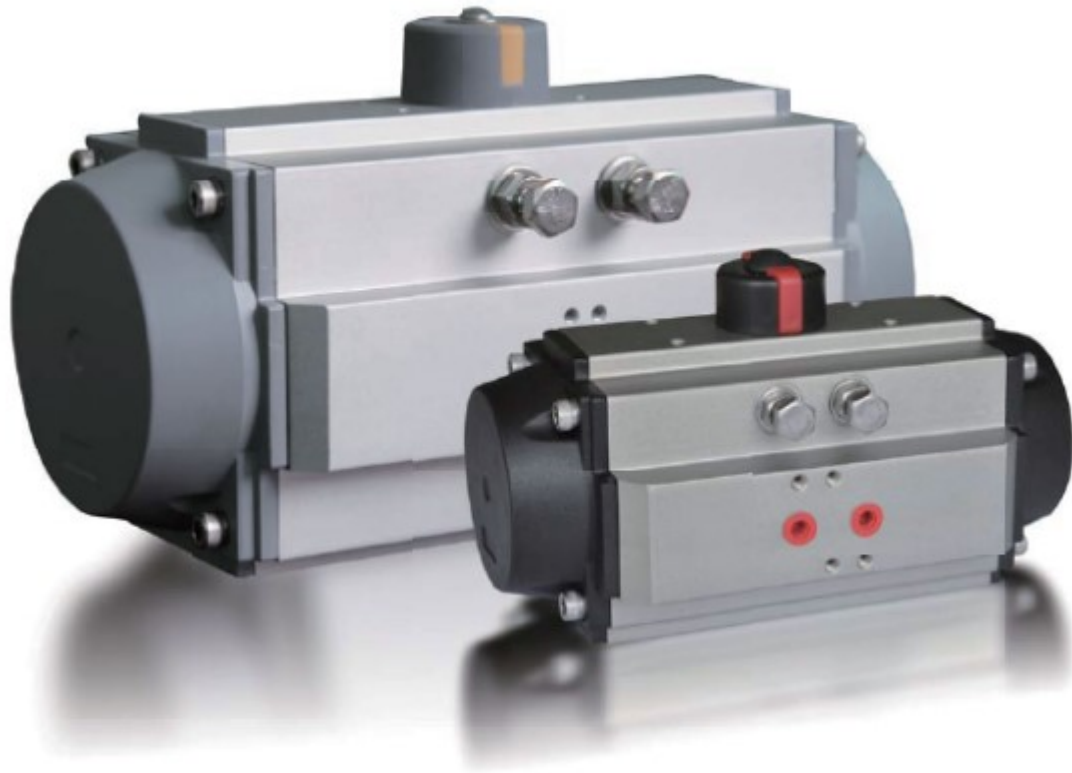

Design

VT series rack and pinion pneumatic actuators apply innovative drive mechanism, integrating the latest pneumatic actuator technology and materials. The series is designed as per extensive field mounting and application experience with following product strengths:

- ☆ High performance and high reliability
- ☆ Fully compliant with the latest international standards and regulations
- ☆ More applicable to a wide range of specifications and higher cost performance
- ☆ Compact design is better suited for a variety of industrial applications

Structure

1. Integrate and compact design utilizes the same body and end caps for double acting and spring return actuator in the same model. It also benefits less spare parts inventory and is greatly convenient for customers' field application by adding or removing spring cartridges.

2. Fully compliant with the latest international standards including ISO5211, DIN3337 and VDI/VDE3845, etc. Fully compliant with NUMAR standard and convenient to replace or mount accessories including solenoid valves, limit switches.

3. Apply rack and pinion with double pistons in advantages of compact structure, high cycle life, and swift operation. It is convenient to switch rotation direction only by inverting the pistons for symmetrical mounting position design.

4. Dual independent travel stoppers can be conveniently and precisely implement $\pm 4^\circ$ adjustments externally in two directions, allowing actuators in alignment with valve on both the opening and closing phases of the stroke.

5. The composite bearings and guides on pinion and piston ensure precise operation, low friction and high life cycle, preventing output shaft from fractures.

6. Integrate design of bearing and guide improves security with high resistance to fractures and long cycle life for Nickel plating process.

7. Rack and pinion tooth in high precision realize less clearance, accurate drive and high output power.

8. Extruded aluminum body is processed with corrosion resistance internally and externally. Fine ground cylinder surface lead to low friction coefficient and high cycle life.

9. Modularized preload spring cartridges with special coating is applicable to a wide range of scenarios with high security and anticorrosion.

10. High-quality bearings are of reliable sealing, low friction, high cycle life and wide range of application temperature.

11. All of the internal and external fasteners are made in long term corrosion-resistant stainless steel.

12. Multifunctional position indicator with slot in compliance with NAMUR standard offers simplicity and clarity for visual indication. Connection to a variety of standard and common sensors can be easily realized.

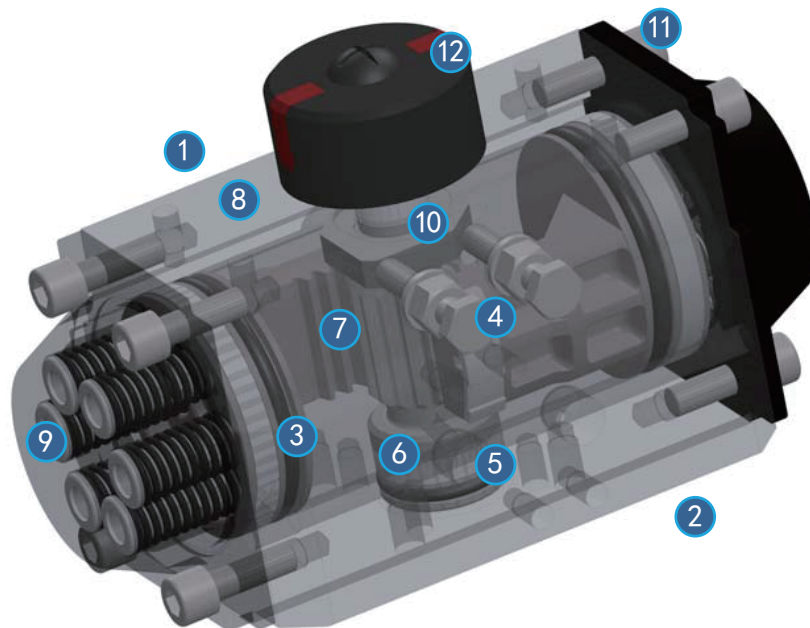

Product Selection Range, Accessories and Quality Management

Selection Range:

A: Actuators in all specifications are supplied with 304 or 316 stainless steel output shafts as requested.

B: For applications under extremely high and low temperature, all models are supplied with corresponding FPM or silicone rubber O-ring with special lubricant.

C: The female pinion drive is standard with double square and diagonal square output drive at the bottom, and optional with keyed drive, flat head drive. And customized design as per customers' specific requirements is also available.

Quality Management:

- VT series pneumatic actuators production process is fully compliant with ISO9001.
- 100% of all units are factory pressure and leak tested and externally marked with dedicated serial number for traceability.
- 100% of all units are individually boxed with suitable cardboard carton for protection and appropriately labeled in detail for identification.

Optional Accessories:

- Bracket
- Solenoid Valve
- Proximity Sensor
- Gear Box(Manual Gear Override)
- Complete set of square output shaft in reduced sizes
- Connector
- Limit Switch Box
- Positioner

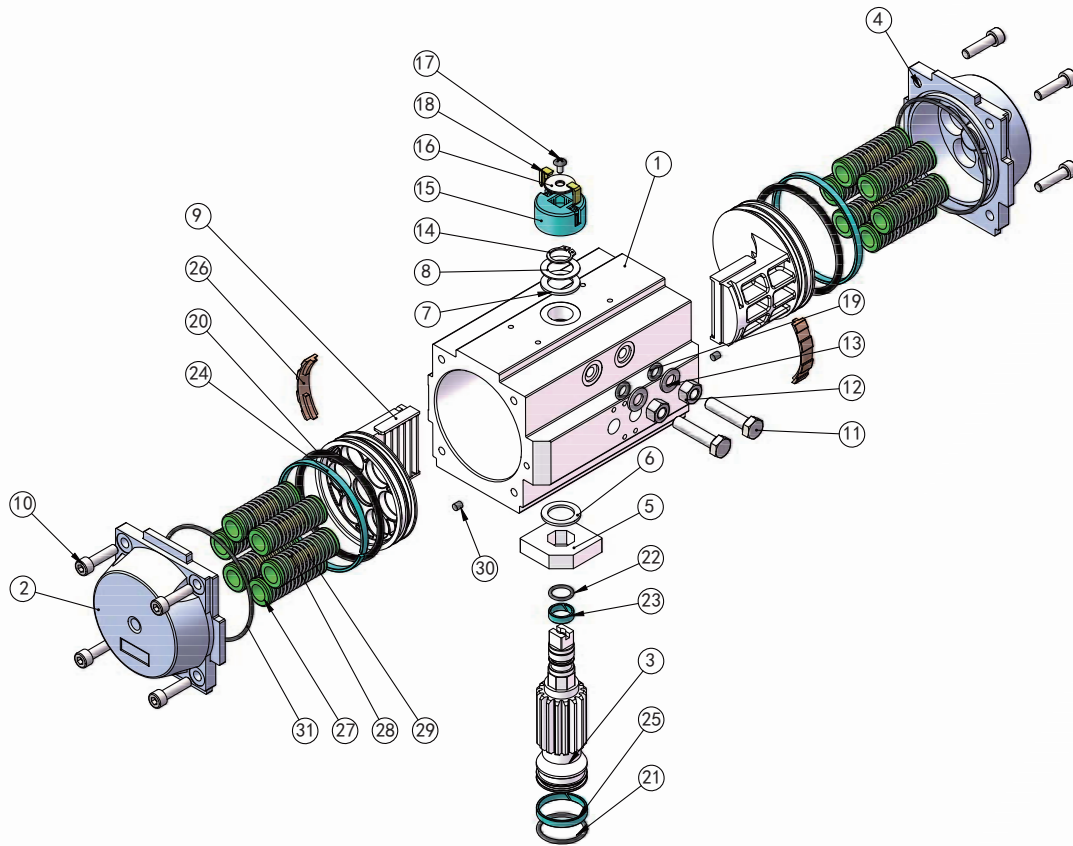

Item No.	Description	Materials	Qty.	Item No.	Description	Materials	Qty.	Item No.	Description	Materials	Qty.
1	Body	Aluminum Alloy	1	12	Travel Stop Nut	Stainless Steel	2	23	Upper Pinion Bearing	Advanced Polymer	1
2	Left End Cap	Aluminum Alloy	1	13	Travel Stop Washer	Stainless Steel	2	24	Piston Wear Bearing	Advanced Polymer	2
3	Pinion	45# Steel	1	14	Retaining Ring	Spring Steel	1	25	Lower Pinion Bearing	Advanced Polymer	1
4	Right End Cap	Aluminum Alloy	1	15	Indicator	Advanced Polymer	1	26	Piston Skate	Advanced Polymer	2
5	OCH-CAM	45# Steel	1	16	Indicator Thrust Bearing	Stainless Steel	1	27	Spring Skate	Advanced Polymer	24
6	Upper Pinion Thrust Bearing	Advanced Polymer	1	17	Flat Head Cross Bolt	Stainless Steel	1	28	Spring	Spring Steel	12
7	Thrust Bearing	Advanced Polymer	1	18	Color Code	Advanced Polymer	2	29	Straining Beam	Copper Pipe	12
8	Thrust Washer	Stainless Steel	1	19	O-ring (Travel Stop)	NBR	2	30	Plug	NBR	2
9	Travel Stop Piston	Aluminum Alloy	2	20	O-ring (Piston)	NBR	2	31	O-ring (End Cap)	NBR	2
10	End Cap Bolt	Stainless Steel	8	21	O-ring (Lower Pinion)	NBR	1				
11	Travel Stop	Stainless Steel	2	22	O-ring (Upper Pinion)	NBR	1				

Technical Data (Metric Unit)

Model	V T032		V T050		V T065		V T075		V T085		V T095		V T110		V T125		V T140		V T160		V T190		V T210		V T240		V T270		V T300		V T350		V T400	
	D	S	D	S	D	S	D	S	D	S	D	S	D	S	D	S	D	S	D	S	D	S	D	S	D	S	D	S	D	S	D	S		
Diameter(mm)	32		50		65		75		85		95		110		125		140		160		190		210		240		270		300		350		400	
Air Volume Opening(L)	0.03		0.09		0.19		0.30		0.44		0.88		0.83		1.41		1.76		2.85		4.75		6.60		11.40		15.80		19.09		27.65		42.81	
Air Volume Closing(L)	0.04		0.15		0.32		0.50		0.66		1.17		1.27		2.13		2.72		4.08		7.20		10.29		15.10		18.80		28.23		44.10		62.05	
Opening Time(s)	0.3		0.3	0.9	0.4	0.9	0.4	0.9	0.9	1.0	0.9	1.4	0.9	1.4	1.3	2.4	1.3	2.8	2.0	4.8	2.2	2.4	2.9	3.4	3.2	3.8	4.4	5.0	5.0	6.0	6.2	7.4	7.5	9.6
Closing Time(s)	0.4		0.4	0.7	0.4	0.8	0.4	0.9	0.9	1.2	1.0	1.4	1.0	1.6	1.4	2.4	1.4	3.0	2.4	4.9	2.6	3.0	3.8	4.1	3.7	4.0	4.9	5.5	6.0	6.8	7.2	8.4	8.5	10.6
Weight (kg)	0.47		1.13	1.25	1.97	2.21	2.93	3.29	3.78	4.26	5.14	5.86	6.09	7.17	10.86	12.54	13.77	15.93	20.15	23.75	28.41	33.81	40.03	48.43	52.6	77.76	73.64	90.6	108	135.6	146.7	188.1	220.5	283.5

Notice: (A) The operation time above are measured in following experimental conditions:

1.For model 32-160

(1)Room temperature (2)Actuator stroke 90° (3)Solenoid valve with orifice of 4 mm and a flow capacity Qn400L/min (4)Inside pipe diameter 6 mm (5) Neutral clean air (6)Air supply pressure 5.5 bar

(7)Actuator without external resistance load

2.For model 190-400

(1)Room temperature (2)Actuator stroke 90° (3)Solenoid valve with orifice of 12 mm and a flow capacity Qn5100L/min (4)Inside pipe diameter 8 mm (5)Neutral clean air (6)Air supply pressure 5.5 bar

(7)Actuator without external resistance load

Cautions: obviously on the field applications when one or more parameters are different from above, the operation time will be different. Air consumption rest with air supply, open/switch stroke, air volume and action cycle times.

Expressions:

$$L/min = \text{Air volume}(\text{opening air volume} + \text{closing air volume}) \times \frac{[\text{Air Supply}(\text{Kpa}) + 101.3]}{101.3} \times \text{Action times}(/min)$$

Torque-Metric Torque Output

Double Acting Torque Output Diagram

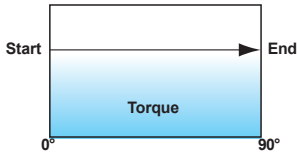

Spring Return Torque Output Diagram

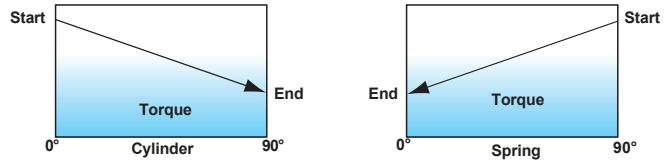

Double Acting Actuator Torque (N.m)

Model	Air Supply (Unit Bar)										
	2.5	3	3.5	4	4.5	5	5.5	6	7	8	
VT032	2.9	3.4	4.0	4.6	5.3	5.9	6.5	7.1	8.3	9.5	
VT050	8.6	10.4	12.3	14.2	16.0	17.9	19.8	21.6	25.4	29.1	
VT065	17.4	21.2	25.0	28.7	32.5	36.3	40.1	43.9	51.4	59.0	
VT075	27.0	32.9	38.8	44.7	50.5	56.4	62.3	68.2	79.9	91.7	
VT085	39.7	48.3	56.9	65.6	74.2	82.8	91.4	100.1	117.3	134.6	
VT095	55.7	67.9	80.0	92.1	104.2	116.4	128.5	140.6	164.8	189.1	
VT110	72.0	89.3	105.0	120.6	136.3	152.0	167.6	183.3	214.6	245.9	
VT125	128.7	159.5	187.5	215.4	243.4	271.4	299.4	327.4	383.3	439.3	
VT140	196	237	278	319	360	401	442	483	565	647	
VT160	263.5	326.6	383.9	441.2	498.5	555.8	613.1	670.4	785.0	899.7	
VT190	428.5	518.0	607.3	696.6	785.9	875.3	964.6	1053.9	1232.5	1411.1	
VT210	598.2	723.2	847.9	972.6	1097.3	1222.0	1346.6	1471.3	1720.7	1970.1	
VT240	928.3	1122.0	1315.0	1508.0	1702.0	1895.0	2089.0	2282.0	2669.0	3056.0	
VT270	1305.0	1577.0	1849.0	2121.0	2393.0	2665.0	2937.0	3209.0	3753.0	4297.0	
VT300	1678.6	2029.4	2379.3	2729.2	3079.1	3429.0	3778.9	4128.8	4828.5	5528.3	
VT350	2492.5	3011.8	3531.1	4050.4	4569.6	5088.9	5608.2	6127.5	7166.0	8204.6	
VT400	3798.1	4589.4	5380.7	6172.0	6963.3	7754.5	8545.8	9337.1	10919.7	12502.2	

Spring Return Actuator Torque (N.m)

Model	Air Supply (Unit:bar)																				Spring Return (Nm)	
	2.5		3		3.5		4		4.5		5		5.5		6		7		8			
	0°	90°	0°	90°	0°	90°	0°	90°	0°	90°	0°	90°	0°	90°	0°	90°	0°	90°	0°	90°	90°	0°
VT050S05	5.1	3.4	6.9	5.3	8.8	7.2	10.7	9.0	12.5	10.9	14.4	12.8	16.3	14.6	18.1	16.5	21.9	20.2	25.6	23.9	5.2	3.5
VT050S06	4.4	2.4	6.2	4.3	8.1	6.1	10.0	8.0	11.8	9.9	13.7	11.7	15.6	13.6	17.4	15.5	21.2	19.2	24.9	22.9	6.2	4.2
VT050S07			5.5	3.2	7.4	5.1	9.3	7.0	11.1	8.8	13.0	10.7	14.9	12.6	16.7	14.4	20.5	18.2	24.2	21.9	7.2	4.9
VT050S08				6.7	4.1		8.6	5.9	10.4	7.8	12.3	9.7	14.2	11.5	16.0	13.4	19.8	17.1	23.5	20.9	8.2	5.6
VT050S09							7.9	4.9	9.7	6.8	11.6	8.6	13.5	10.5	15.3	12.4	19.1	16.1	22.8	19.8	9.3	6.3
VT050S10								9.0	5.7	10.9	7.6	12.8	9.5	14.6	11.3	18.4	15.1	22.1	18.8	10.3	7.0	
VT050S11										10.2	6.6	12.1	8.4	13.9	10.3	17.7	14.0	21.4	17.8	11.3	7.7	
VT050S12													11.4	7.4	13.2	9.3	17.0	13.0	20.7	16.7	12.4	8.4
VT065S05	8.7	4.3	12.5	8.1	16.3	11.9	20.0	15.6	23.8	19.4	27.6	23.2	31.4	27.0	35.2	30.8	42.7	38.3	50.3	45.9	13.1	8.7
VT065S06	7.0	1.7	10.7	5.5	14.5	9.2	18.3	13.0	22.1	16.8	25.9	20.6	29.7	24.4	33.4	28.2	41.0	35.7	48.6	43.3	15.7	10.4
VT065S07			9.0	2.8	12.8	6.6	16.6	10.4	20.4	14.2	24.1	18.0	27.9	21.8	31.7	25.5	39.3	33.1	46.8	40.7	18.3	12.2
VT065S08				11.0	4.0		14.8	7.8	18.6	11.6	22.4	15.4	26.2	19.1	30.0	22.9	37.5	30.5	45.1	38.1	21.0	13.9
VT065S09							13.1	5.2	16.9	9.0	20.7	12.7	24.4	16.5	28.2	20.3	35.8	27.9	43.4	35.4	23.6	15.7
VT065S10								15.1	6.3	18.9	10.1	22.7	13.9	26.5	17.7	34.0	25.2	41.6	32.8	26.2	17.4	
VT065S11										17.2	7.5	21.0	11.3	24.7	15.1	32.3	22.6	39.9	30.2	28.8	19.1	
VT065S12													19.2	8.7	23.0	12.4	30.6	20.0	38.1	27.6	31.4	20.9
VT075S05	16.3	10.2	22.2	16.0	28.1	21.9	34.0	27.8	39.8	33.7	45.7	39.6	51.6	45.4	57.5	51.3	69.2	63.1	81.0	74.8	16.9	10.7
VT075S06	14.2	6.8	20.1	12.7	25.9	18.6	31.8	24.4	37.7	30.3	43.6	36.2	49.4	42.1	55.3	47.9	67.1	59.7	78.8	71.4	20.2	12.8
VT075S07			17.9	9.3	23.8	15.2	29.7	21.1	35.6	26.9	41.4	32.8	47.3	38.7	53.2	44.6	64.9	56.3	76.7	68.1	23.6	15.0
VT075S08				21.7	11.8		27.5	17.7	33.4	23.6	39.3	29.4	45.2	35.3	51.0	41.2	62.8	53.0	74.5	64.7	27.0	17.1
VT075S09							25.4	14.3	31.3	20.2	37.1	26.1	43.0	32.0	48.9	37.8	60.7	49.6	72.4	61.3	30.3	19.3
VT075S10								29.1	16.8	35.0	22.7	40.9	28.6	46.8	34.5	58.5	46.2	70.3	58.0	33.7	21.4	
VT075S11										32.9	19.3	38.7	25.2	44.6	31.1	56.4	42.8	68.1	54.6	37.1	23.5	
VT075S12													36.6	21.8	42.5	27.7	54.2	39.5	66.0	51.2	40.4	25.7
VT085S05	23.2	13.7	31.8	22.3	40.4	30.9	49.0	39.5	57.6	48.1	66.3	56.8	74.9	65.4	83.5	74.0	100.8	91.3	118.0	108.5	26.1	16.6
VT085S06	19.8	8.4	28.4	17.0	37.1	25.7	45.7	34.3	54.3	42.9	62.9	51.5	71.6	60.2	80.2	68.8	97.4	86.0	114.7	103.3	31.3	19.9
VT085S07			25.1	11.8	33.8	20.5	42.4	29.1	51.0	37.7	59.6	46.3	68.3	55.0	76.9	63.6	94.1	80.8	111.4	98.1	36.5	23.2
VT085S08				30.4	15.2		39.1	23.9	47.7	32.5	56.3	41.1	64.9	49.7	73.6	58.4	90.8	75.6	108.1	92.9	41.7	26.5
VT085S09							35.8	18.7	44.4	27.3	53.0	35.9	61.6	44.5	70.3	53.2	87.5	70.4	104.8	87.7	46.9	29.8
VT085S10								41.1	22.1	49.7	30.7	58.3	39.3	67.0	48.0	84.2	65.2	101.5	82.5	52.1	33.1	
VT085S11										46.4	25.5	55.0	34.1	63.6	42.7	80.9	60.0	98.1	77.2	57.3	36.4	
VT085S12													51.7	28.9	60.3	37.5	77.6	54.8	94.8	72.0	62.5	39.7
VT095S05	33.6	20.9	45.8	33.0	57.9	45.1	70.0	57.3	82.1	69.4	94.3	81.5	106.4	93.6	118.5	105.8	142.7	130.0	167.0	154.2	34.9	22.1
VT095S06	29.2	13.9	41.4	26.1	53.5	38.2	65.6	50.3	77.7	62.4	89.8	74.5	102.0	86.7	114.1	98.8	138.3	123.0	162.6	147.3	41.8	26.5
VT095S07			36.9	19.1	49.1	31.2	61.2	43.3	73.3	55.4	85.4	67.6	97.5	79.7	109.7	91.8	133.9	116.1	158.1	140.3	48.8	30.9
VT095S08				44.6	24.2		56.8	36.4	68.9	48.5	81.0	60.6	93.1	72.7	105.2	84.8	129.5	109.1	153.7	133.3	55.8	35.4
VT095S09							52.3	29.4	64.5	41.5	76.6	53.6	88.7	65.8	100.8	77.9	125.1	102.1	149.3	126.4	62.7	39.8
VT095S10								60.0	34.5	72.2	46.7	84.3	58.8	96.4	70.9	120.6	95.1	144.9	119.4	69.7	44.2	
VT095S11										67.7	39.7	79.9	51.8	92.0	63.9	116.2	88.2	140.5	112.4	76.7	48.6	
VT095S12													75.4	44.8	87.6	57.0	111.8	81.2	136.0	105.4	83.6	53.0
VT110S05	43.4	26.2	60.7	43.4	76.4	59.1	92.0	74.8	107.7	90.4	123.4	106.1	139.0	121.8	154.7	137.4	186.0	168.8	217.3	200.1	45.9	28.6
VT110S06	37.7	17.0	55.0	34.3	70.6	49.9	86.3	65.6	102.0	81.3	117.6	96.9	133.3	112.6	149.0	128.3	180.3	159.6	211.6	190.9	55.0	34.3
VT110S07			49.3	25.1	64.9	40.8	80.6	56.4	96.2	72.1	111.9	87.8	127.6	103.4	143.2	119.1	174.6	150.4	205.9	181.8	64.2	40.0
VT110S08				59.2	31.6		74.9	47.3	90.5	62.9	106.2	78.6	121.9	94.3	137.5	109.9	168.9	141.3	200.2	172.6	73.4	45.8
VT110S09							69.1	38.1	84.8	53.8	100.5	69.4	116.1	85.1	131.8	100.8	163.1	132.1	194.5	163.4	82.5	51.5
VT110S10								79.1	44.6	94.8	60.3	110.4	75.9	126.1	91.6	157.4	122.9	188.7	154.2	91.7	57.2	
VT110S11										89.0	51.1	104.7	66.7	120.4	82.4	151.7	113.7	183.0	145.1	100.9	62.9	
VT110S12													99.0	57.6	114.6	73.2	146.0	104.6	177.3	135.9	110.0	68.6

Sample Reference

Applicable Specification:
VT050~VT160

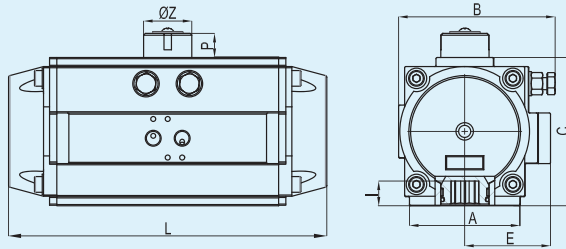

Applicable Specification:
VT032

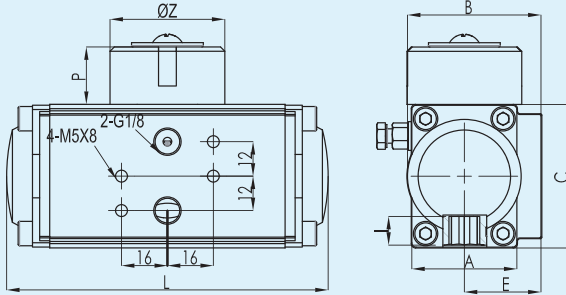

Applicable Specification:
VT190~VT350

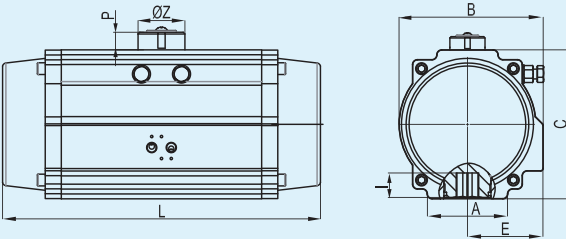

Applicable Specification:
VT400

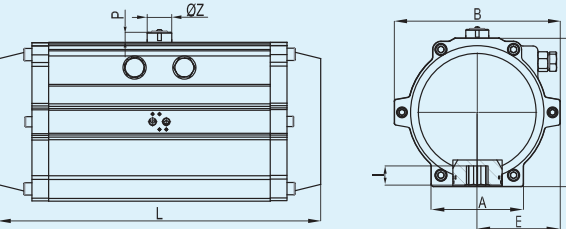

Top View

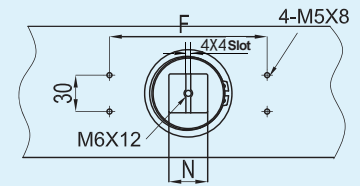

Air Supply Interface

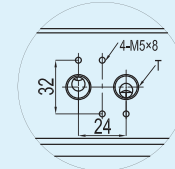

G1/4 NAMUR Standard
Applicable to VT50-VT210

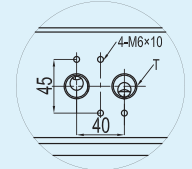

G1/2 NAMUR Standard
Applicable to VT240-VT400

Bottom View

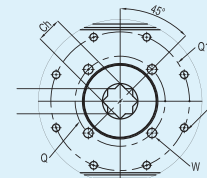

Applicable Specification : VT350

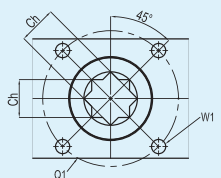

Applicable Specification :
VT032, VT210 - VT300

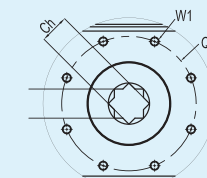

Applicable Specification :VT400

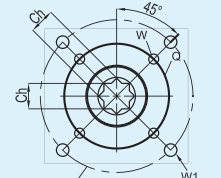

Applicable Specification :
VT50 - VT190

VT Series Pneumatic Actuator Dimension Table (Unit: mm)

Model	A	B	C	L	E	F	P	ØZ	N	I	Flange Type	Q	Q1	W	W1	Ch	T
VT032	37	47	50	110	27	50	20	40	10	10	F03	-	36	-	M5×8	9×9	G1/8"
VT050	45	70.5	70	154	41.5	80	20	40	10	12	F03/05	36	50	M5×7.5	M6×9	11×11	G1/4"
VT065	62	89.5	89	189	51.5	80	20	40	10	16	F05/07	50	70	M6×9	M8×12	14×14	G1/4"
VT075	68	102.5	100	210	59	80	20	40	14	16	F05/07	50	70	M6×9	M8×12	14×14	G1/4"
VT085	68	112.5	113	229	63.5	80	20	40	14	19	F05/07	50	70	M6×9	M8×12	17×17	G1/4"
VT095	92	126	123	264	71	80	20	40	14	19	F05/07	50	70	M6×9	M8×12	17×17	G1/4"
VT110	93	138.5	136	266	76.5	80	20	40	14	19	F07/10	70	102	M8×12	M10×15	17×17	G1/4"
VT125	96	157	161	337	85	80	30	56	22	25	F07/10	70	102	M8×12	M10×15	22×22	G1/4"
VT140	110	178	178	377	97	80/130	30	56	22	31	F10/12	102	125	M10×15	M12×18	27×27	G1/4"
VT160	112	196	200	414	106	80/130	30	56	22	31	F10/12	102	125	M10×15	M12×18	27×27	G1/4"
VT190	136	216.5	232	490	112	130	30	56	22	41	F10/14	102	140	M10×15	M16×24	36×36	G1/4"
VT210	140	235.5	255	550	120	130	30	80	32.5	40	F14	-	140	-	M16×24	36×36	G1/4"
VT240	159	262	292	602	131	130	30	80	32.5	50	F16	-	165	-	M20×25	46×46	G1/2"
VT270	159	295	331	672	147.5	130	30	80	32.5	50	F16	-	165	-	M20×25	46×46	G1/2"
VT300	180	335	354	784	173	130	30	80	32.5	50	F16	-	165	-	M20×25	46×46	G1/2"
VT350	270	385	410	845	195	130	30	80	32.5	50	F16/F25	165	254	M20×25	M16×24	46×46	G1/2"
VT400	290	520	466	956	260	130	30	80	32.5	60	F25	-	254	-	M16×24		G1/2"

Model	Type	Spring Qty.	Flange Type	Square	Option	Sealing Part	
VT032	D=Double Acting	Dedicated to Spring Return	F03	9×9	End Cap Color RAL ■ 7046 ■ 9004 ■ 5021 ■ 3020 ■ 6002 ■ 5015 Cylinder Type P Smooth Surface& Hard Anodized S Sandblasted Surface&Hard Anodized (Color:Grey) H Sandblasted Surface&Hard Anodized (Color:Dark Grey) F Sandblasted Surface&Hard Anodized&PTFE Coated	Standard Nitrile Rubber -18°C~+80°C HT Fluororubber (High Temperature) -18°C~+150°C LT Silastic (Low Temperature) -40°C~+80°C	
VT050			F03/05	11×11			
VT065			F05/07	14×14			
VT075			F05/07	14×14			
VT085			F05/07	17×17			
VT095			4	F05/07			17×17
VT110			5	F07/10			17×17
VT125			6	F07/10			22×22
VT140			7	F10/12			27×27
VT160			8	F10/12			27×27
VT190			9	F10/14			36×36
VT210			S=Spring Return	10			F14
VT240	F16	46×46					
VT270	F16	46×46					
VT300	F16	46×46					
VT350	F16/25	46×46					
VT400	F25	55×55					

Remarks:

1. The standard rotation of double acting and spring return is clockwise to close.
2. Sealing parts come standard with normal temperature ranges of -18°C to 80°C, Corresponding sealing types are available for environment at high or low temperature.